

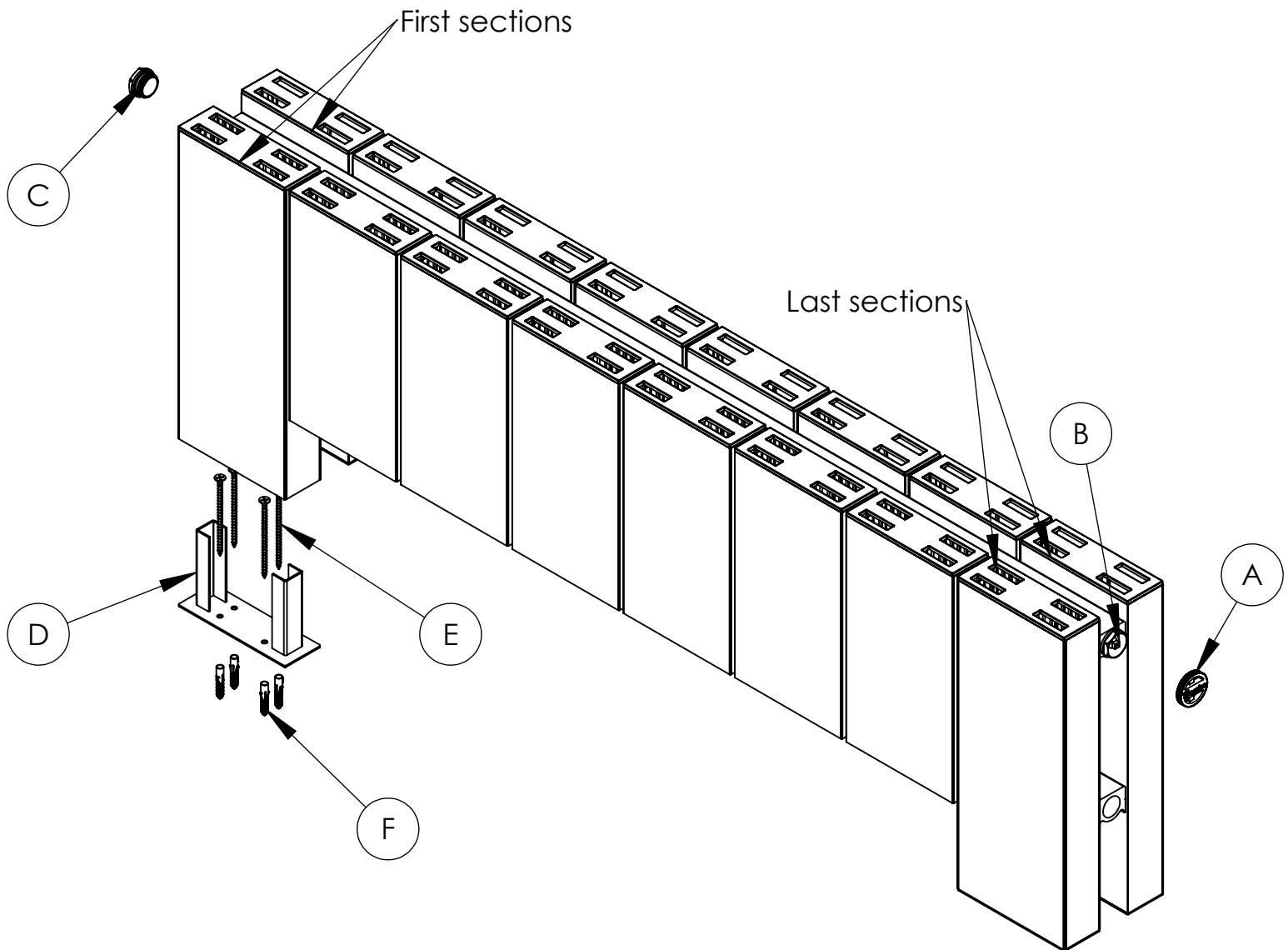





# ELVINO FLOOR DOUBLE

## FITTING INSTRUCTIONS



Key	Component	Qty
	<b>A</b> Bleeding Valve Key	<b>1</b>
	<b>B</b> Bleeding Valve 1/2 "	<b>1</b>
	<b>C</b> Blind tap	<b>1</b>
	<b>D</b> Floor Fixing Piece	<b>4</b>
	<b>E</b> Screw	<b>16</b>
	<b>F</b> Plug	<b>16</b>

### Assembly Instructions

Use Carisa bleeding valve key (A) to turn bleeding valve on final installation (B).

Accurately mark out fixing pieces's holes on floor using spirit level.

Drill sixteen 8mm hole for each floor fixing piece (D).

Screw floor fixing piece (D) into plugs (F) with screws (E).

Position the first and last sections of the radiator centered on the floor fixings.