







Key	Component	Qty
	A Friction Cups/Cushions	4
	B Left Bracket	2
	C Right Bracket	2
	D Screw-22x45mm	8
	E Wall Plug	8
	F Thermostat	1



Assembly Instructions

Accurately mark out bracket holes on wall using spirit level.

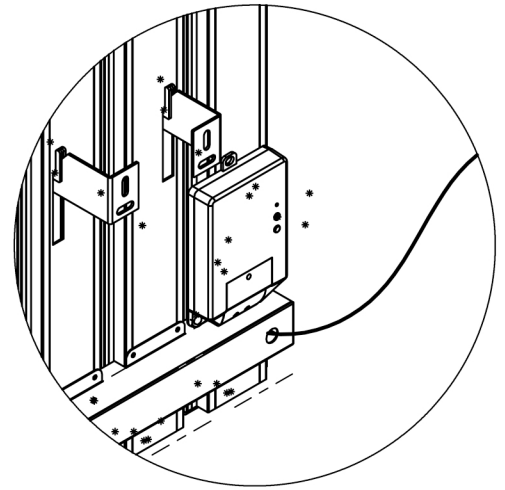
Drill four 8mm diameter holes for left brackets (B) and four 8mm diameter holes for right brackets(C).

Friction cups (A) **MUST** be fitted to each mounting brackets (B,C) to suppress potential noise.

Screw brackets (B,C) into wall plugs (E) with 22mm x 45mm screws (D).

Hang radiator by sliding the bosses on the back of the radiator into brackets (B,C).

“ Attention! Radiator cannot be fitted upside down. The power cable and control modem are down side. Otherwise,product can has break-down and will be considered out of